



CML-B4-250

ELEVATION SYSTEMS

CML-B4-250 (GR) SPECIALLY COMPATIBLE WITH: VNL-G2 - VNL-GB2

	250 kg
	450 kg
	+ 270°

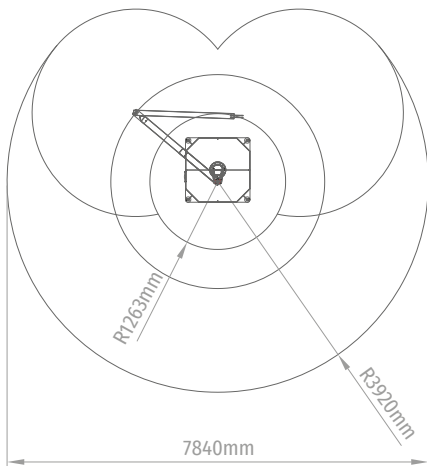

**BASE FILLED WITH GRAVEL
(GRAVEL NOT INCLUDED)**

CML-B4-250 (GR) GRAVEL

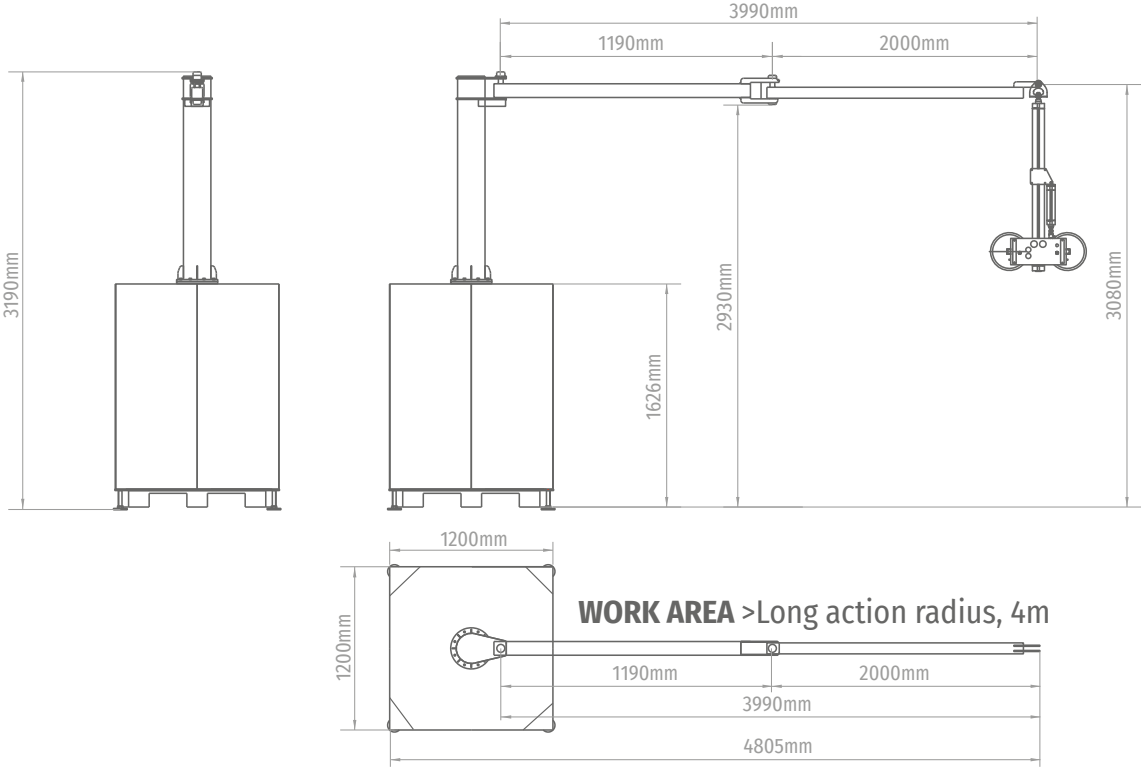

Pictures of OTHER OPTIONS See details on next page



CML-B4-250 OTHER OPTIONS

ELEVATION SYSTEMS

CML-B4-250 (WA) WALL

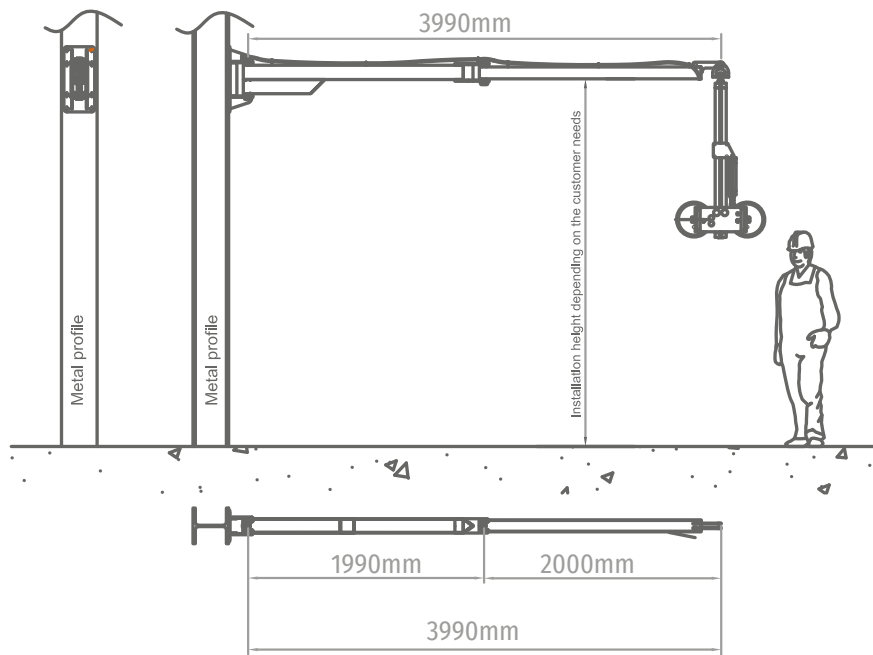

CML-B4-250 (MP) METAL PLATE

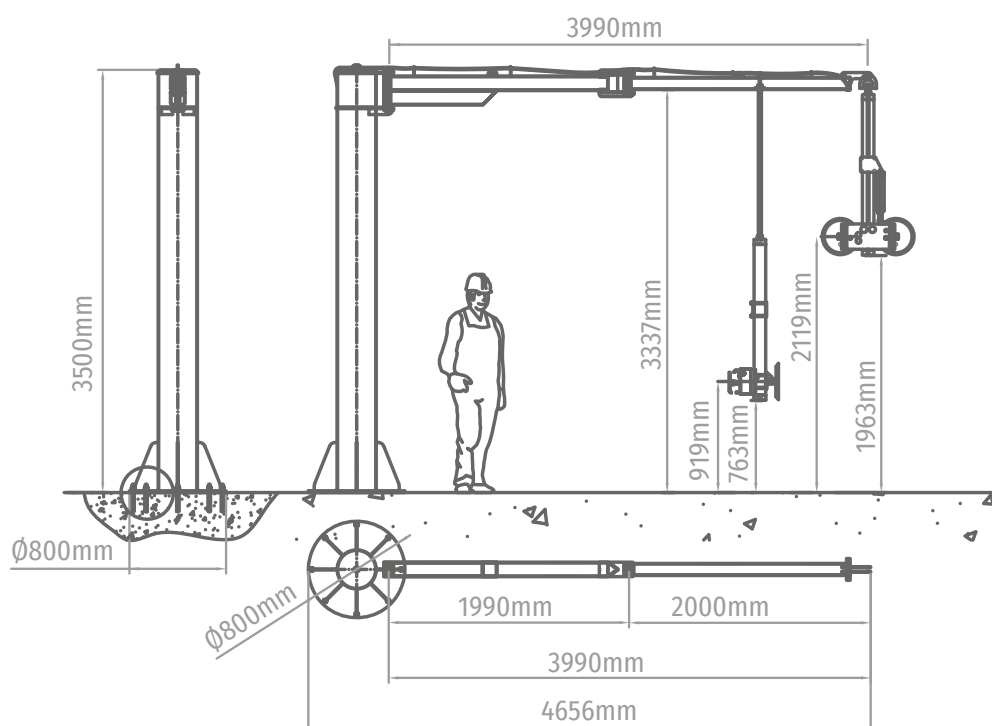

CML-B4-250 (WA) WALL + BRACKETS

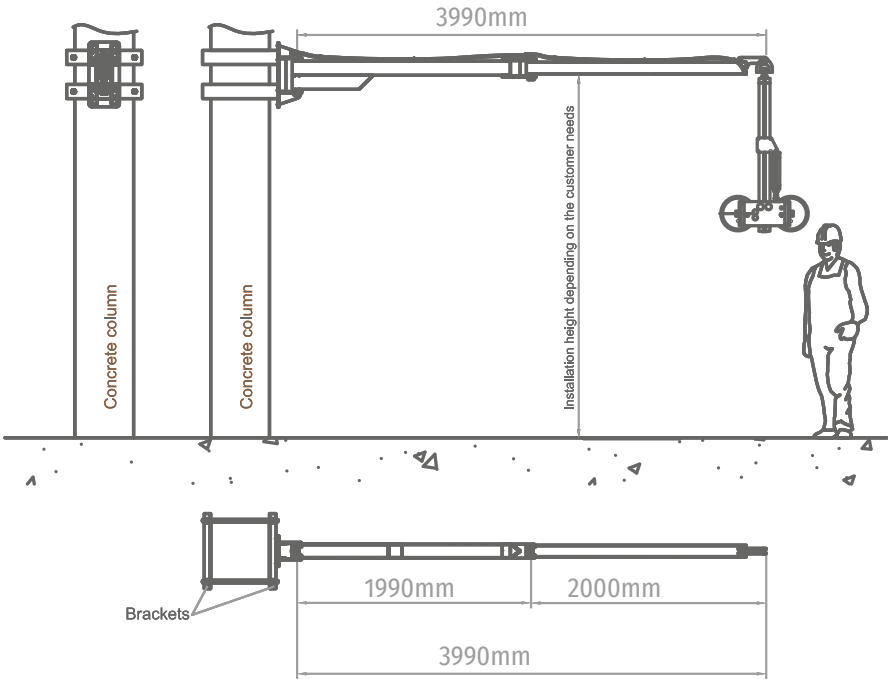

CML-B4-250 (MC) METAL COUNTERWEIGHT

