

XLO

XLO-90-2 | XLO-300-2 | XLO-90-1 | XLO-300-1





WORK SERIES



XLO



OPTIONALS

- 2105844 METAL BOX (ONLY XLO-90)
- FU-P COVERS
- MI-04A WIRELESS REMOTE CONTROL
- 2105841 PUSHBUTTON WITH 3m CABLE

	220-240V (50-60 Hz)
	60 W
	OK
	NO

	30 L/min
	OK - BATTERY 12V
	OK

XL0-90-2

	300 kg
	90 kg
	24 kg
	0° - 60° - 90°

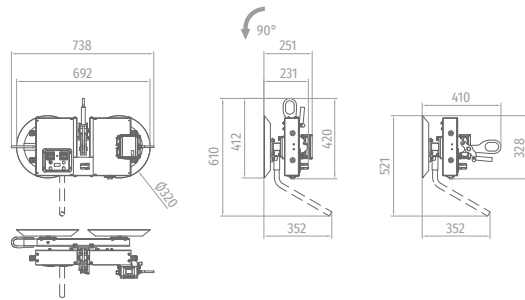

XL0-300-2

	600 kg
	300 kg
	49 kg
	0° - 60° - 90°

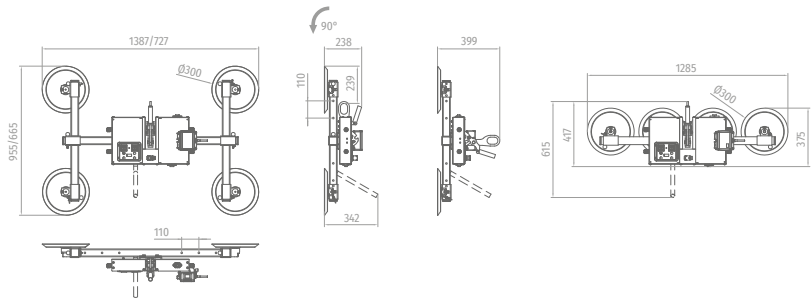

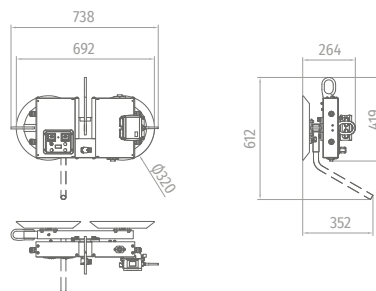

XL0-90-1

	300 kg
	90 kg
	23 kg
	NO



XL0-300-1

	600 kg
	300 kg
	48 kg
	NO

